

A system on the move:

Food serving carts, food transport carts and
dispensers from BLANCO INMOTION.

blancoinmotion

realsupport

Motion in the kitchen.

Exemplary in function and design:

The new ergonomic **BLANCO INMOTION** food serving carts and dispensers really shine thanks to a host of **details** which really help you move forward.

The large **selection of models** offers a fitting solution for any task – **unheated** or **heatable, with cooling slits** or **with active convection cooling**.

The SAG 2-THK is a real all-rounder, which integrates a **heatable** and a **cooled compartment, 2 bain-marie wells** in the cover and a **heatable plate dispenser**, all in a small package.

CONTENTS

The ergonomic push handles	4
The new corner guards	5
Product overview by product abbreviations	5
Food transport and distribution with BLANCO INMOTION	6
The all-rounder: SAG 2-THK	7
An overview of product advantages . . .	8

PRODUCT OVERVIEW

Food serving cart	10
Food transport cart	13
Accessories/castors for SAW, SAG, STW	14
Platform dispenser	16
Basket dispenser	17
Tray dispenser	19
Universal dispenser	20
Plate dispenser, heatable	22
Basket dispenser for installation	25
Plate dispenser for installation	26
Tray dispenser for installation	28
Universal dispenser for installation . . .	29
Accessories/Castors for dispenser . . .	30



Strong support: The ergonomic push handles.

Transport means motion: for better maneuverability and handling, BLANCO has adopted **push handles** and **optimized them ergonomically**.

Little things often make a big difference:

- Continuous handle for **flexible handling**
- Additional **bumper rail** and **natural handle shape** thanks to new-style installation
- Larger diameter (**32 mm**) for **more secure grip** and an attractive, modern design



FOOD SERVING CARTS

SAW 3
with accessories



PLATE DISPENSERS

2 SEK 21-26
with accessories



cornerstones

Welcome to the buffer zone: The new corner guards.

Transport often means maneuvering in tight spots.

To prevent furniture and other objects from being damaged, **new corner guards** have been designed for the **BLANCO INMOTION** line.



UNIVERSAL DISPENSERS

UNI-H 59/29
with accessories

Overview by product abbreviations

ABBREV.	PRODUCT	PAGE
CCE	Tray dispenser and basket dispenser, open	18-19
CE	Tray dispenser, basket dispenser and platform dispenser, closed	16, 18, 19
CEB	Basket dispenser, tray dispenser for installation	25, 28
CEBH	Basket dispenser for installation, heatable	25
CEK	Basket dispenser with cooling slits	17-18
CE-UK	Basket dispenser, cooled (convection)	17
CHV	Platform dispenser and basket dispenser, convection heated	16-17
RE	Plate dispenser for installation	26-27
RHE	Plate dispenser for installation, heatable	27
SAG	Food serving cart, closed	12
SAW	Food serving cart, open	10
SAW-L	Food serving cart, open, for servery counters	11
SAW-UK	Food serving cart, cooled (convection)	11
SE	Plate dispenser, unheated	24
SEK	Plate dispenser with cooling slits	24
SHE	Plate dispenser, heatable	22
SHV	Plate dispenser, convection heated	23
SHVS	Plate dispenser, especially for heat-retaining parts, convection heated	23
STW	Food transport cart	13
UNI	Universal dispenser	21
UNI-B	Universal dispenser for installation	29
UNI-H	Universal dispenser, heatable (convection)	20
UNI-K	Universal dispenser with cooling slits	21



Perfect service:

Food transport and distribution with BLANCO INMOTION.

With the dispensers, food transport and serving carts from **BLANCO INMOTION**, you'll be fully equipped for any task:

- The new, **convection-cooled food serving carts** (SAW-UK) and the **convection-cooled basket dispenser** (CE-UK) help with HACCP-compliant portioning and intermediate storage.
- The **profile edge** (SAW 2-4 and SAG) ensures that the water condensation runs back into the bain-marie wells (thus no danger of injury and slipping).
- The **welded-in board** (SAW) guarantees maximum stability.
- The connection for the power cable is located on the rear of the unit (SAW 2-4) for a **high degree of user-friendliness**.
- A **digital regulator** is available as an option for model STW 2



**CONVECTION-COOLED
FOOD TRANSPORT CART**
SAW 2-UK



FOOD TRANSPORT CART
STW 2
with accessories



The all-rounder: The SAG 2-THK food serving cart.

Versatile, mobile and well thought-out:
The **SAG 2-THK** – a **new development**
for the food serving cart.



One model for any occasion, which
takes care of business with flying colors.

- It's **multi-functional** thanks to a heatable and an active convection-cooled compartment in the underframe
- Additional **heatable plate dispenser**, plate setting secured against inadvertent adjustment
- **Two bain-marie wells** are integrated into the top surface
- Especially **compact construction**
- Also available with **sneeze guard** and **heating shelf**
- Also available in technically simpler **variants** without an active cooled compartment and/or without a plate dispenser



FOOD SERVING CART
SAG 2-THK

all-rounder





frontrun

Extremely persuasive as a package: Food distribution with BLANCO INMOTION.

Hygienic, practical, simply good: Sneeze guard and heating shelf.

The food serving carts are also available with a Sneeze guard and integrated heating shelf: The **stable glass shelf top-unit (sneeze guard)** ensures optimum hygiene, and the **integrated heating shelf** helps with heat retention. Even the last person in line is guaranteed a delicious, warm meal.

BLANCO INMOTION sets standards across the entire field of food distribution. Material, form and function are presented as a highly-attractive unit. The units are compatible with one another and can be adapted to meet your individual needs.

You'll be pleased by the multitude of well thought-out details of the food serving and transport carts from BLANCO INMOTION; it's these details which make everyday work easier. Take the

removable revision panel for the electrical system on the short side, for example, which ensures **maximum service friendliness via easy accessibility**.

The **high-quality finish** and economically sensible price/performance ratio make BLANCO INMOTION a real highlight in the world of professional food distribution.



FOOD SERVING CART
SAG 2-THK with sneeze guard and integrated heating shelf.



UNIVERSAL DISPENSER
UNI-K 59/29 with cooling slits with accessories

ner



Micro-polished surface

The micro-polished stainless-steel CNS 18/10 surface is especially dirt-resistant and ensures optimum hygiene.



Ergonomic push handles

The safety push handle fits especially well in your hands thanks to its 32 mm diameter.



Rugged corner guards

Space a little tight? No problem: the new, wider polyamide corner guards protect furniture and other objects.



High-quality finish

Fused covers offer perfect protection from soiling and water entry.



Cover with profile edge

The profile edge (SAW 2-4 and SAG) ensures that the water condensation runs back into the bain-marie wells, thus preventing the risk of slipping.



Splashed- and sprayed-water protection

All units of the BLANCO INMOTION series are splashed- and sprayed-water protected (Protection type IP X5, except for CE-UK 53/53: IP X4).



Synthetic castors pursuant to DIN standard

The rugged synthetic castors of the basic equipment fulfill all requirements in accordance with DIN 18867, Part 8.



Stamped well numbers

The stamped well numbering ensures easy recognition and makes your work easier.



Cabinet interiors comply with hygiene guidelines

The interiors of the cabinet compartments are produced in the H1 hygienic design.



Welded-in boards

The welded-in boards of the open INMOTION carts ensure maximum stability.



User-friendliness

Easy-to-use operating panels make your day-to-day work easier with all the electrical BLANCO INMOTION units.



Tested safety

All electrical units of the BLANCO INMOTION series are certified according to the latest VDE guidelines (exceptions: SAW-UK, CE-UK).

BLANCO INMOTION

Food serving cart, open

Food serving cart, cooled (convection)

Valid for models SAW 1, SAW 2,
SAW 3, SAW 4, SAW L-2/L-3/L-4:

- **Material CNS 18/10** with micro-polished surface,
- **Welded-in, deep-drawn wells** for Gastronorm 1/1-200 and its subdivision, the wells can be heated wet or dry and can **be heated and regulated individually**,
- **Temperature adjustment of the wells ranges** from +30 °C to +95 °C,
- **CNS safety push handle** with side corner guard elements also serves to

- protect the switch elements,
- **Welded-in support surface**,
- **Stamped fill-level marking** in the wells,
- **Drain valve secured** against inadvertent opening,
- **Protected against splashed and sprayed water** (IP X5),
- **Suitable for optimization systems**,
- Pursuant to **DIN 18867, Part 7**,
- **Synthetic castors**, 4 steering castors, 2 of which have brakes, dia. 125 mm,

- corrosion-resistant pursuant to DIN 18867, Part 8,
- **Solid corner guards** made of plastic (polyamide) protect against damage,
- **VDE certified, GS mark, CE conformity**,
- **Operating panel** with on/off switch, pilot lamp, helix cord connection with dummy plug socket, temperature control on the short side below the push handle,
- **Mains voltage** 220–240 V, 50–60 Hz.



Model	SAW 1	SAW 2	SAW 3 (shown with GN container accessory)	SAW 4
Dimensions L x W x H (in mm)	750 x 508 x 933 mm Operating height: 900 mm	936 x 714 x 933 mm with optional sliding cover: 1,006 x 714 x 1,000 mm Operating height: 900 mm	1,276 x 714 x 933 mm with optional sliding cover: 1,346 x 714 x 1,000 mm Operating height: 900 mm	1615 x 714 x 933 mm Operating height: 900 mm
Weight (in kg)	24,5 kg	35,5 kg	44 kg	57,5 kg
Wattage	0,7 kW	1,4 kW	2,1 kW	2,8 kW
Capacity	1 heat retaining well	2 heat retaining wells	3 heat retaining wells	4 heat retaining wells
Special features	Top surface without profile edge	Top surface with profile edge Helix cord connection with dummy plug socket opposite the operating panel side	Top surface with profile edge Helix cord connection with dummy plug socket opposite the operating panel side	Top surface with profile edge Helix cord connection with dummy plug socket opposite the operating panel side
Accessories/ Options	Fold-out panel on the long sides For other castor designs, see Page 15	Sneeze guard or sneeze guard with heating shelf Fold-out shelf on the short sides and/or the long sides Hinged lid 1/3 : 2/3, (1/3 usable as shelf, 2/3 with integrated lid holder) Sliding cover with synthetic or ball-bearing guide GN lid receptacle for accepting GN 1/1 lids and their subdivision, attached at short side For other castor designs, see Page 15	Sneeze guard or sneeze guard with heating shelf Fold-out shelf on the short sides and/or the long sides Hinged lid 1/3 : 2/3, (1/3 usable as shelf, 2/3 with integrated lid holder) Sliding cover with synthetic or ball-bearing guide GN lid receptacle for accepting GN 1/1 lids and their subdivision, attached at short side For other castor designs, see Page 15	Sneeze guard or sneeze guard with heating shelf Fold-out shelf on the short sides and/or the long sides Hinged lid 1/3 : 2/3, (1/3 usable as shelf, 2/3 with integrated lid holder) GN lid receptacle for accepting GN 1/1 lids and their subdivision, attached at short side For other castor designs, see Page 15
Order No.	572 152	572 153	572 154	572 155

Valid for models SAW 2-UK and SAW 3-UK:

- **Material CNS 18/10** with micro-polished surface,
- **Convection-cooling trough** for GN 1/1-200 and its subdivision integrated in cover, removable convection-cooling trough, evaporator can be folded up,
- **Temperature adjustment ranges** from +2 °C to +15 °C, with an ambient temperature of +32 °C

- **CNS safety push handle** with side corner guard elements also serves to protect the switch elements,
- **Protected against splashed and sprayed water** (IP X5),
- **Suitable for optimization systems**,
- Coolant CFC-free (R 134a),
- Synthetic castors, 2 fixed and 2 steering castors with brakes, dia. 125 mm, corrosion-resistant pursuant to DIN 18867, Part 8,

- **Solid corner guards** made of plastic (polyamide) protect against damage,
- **CE conformity**,
- **Operating panel** with on/off switch, pilot lamp, digital temperature control below the push handle, helix cord connection with dummy plug socket on the long side of the unit,
- **Mains voltage** 220–240 V, 50 Hz.

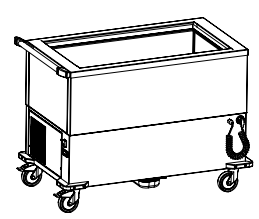
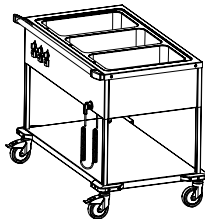

Model	SAW L-2	SAW L-3	SAW L-4 (not shown, similar to SAW L-3)	SAW 2-UK cooled (convection)	SAW 3-UK cooled (convection)
Dimensions L x W x H (in mm)	900 x 749 x 933 mm Operating height: 900 mm	1241 x 749 x 933 mm Operating height: 900 mm	1574 x 749 x 933 mm Operating height: 900 mm	936 x 714 x 933 mm Operating height: 900 mm	1276 x 714 x 933 mm Operating height: 900 mm
Weight (in kg)	35,5 kg	48 kg	65,5 kg	98 kg	118 kg
Wattage	1,4 kW	2,1 kW	2,8 kW	0,4 kW	0,5 kW
Capacity	2 heat retaining wells	3 heat retaining wells	4 heat retaining wells	2 x GN 1/1-200 or their subdivision	3 x GN 1/1-200 or their subdivision
Special features	The operating components and push handle are found on the long side; the cart is specially designed for use at a servery counter	The operating components and push handle are found on the long side; the cart is specially designed for use at a servery counter	The operating components and push handle are found on the long side; the cart is specially designed for use at a servery counter	Convection cooling, cooling capacity: 0.37 kW at $t_0 = -10$ °C (evaporation temp.) and $t_a = +32$ °C (ambient temp.)	Convection cooling, cooling capacity: 0.45 kW at $t_0 = -10$ °C (evaporation temp.) and $t_a = +32$ °C (ambient temp.)
Accessories/ Options	Sneeze guard or sneeze guard with heating shelf GN lid receptacle for accepting GN 1/1 lids and their subdivision, attached on long side below the push handle For other castor designs, see Page 15	Sneeze guard or sneeze guard with heating shelf GN lid receptacle for accepting GN 1/1 lids and their subdivision, attached on long side below the push handle For other castor designs, see Page 15	Sneeze guard or sneeze guard with heating shelf GN lid receptacle for accepting GN 1/1 lids and their subdivision, attached on long side below the push handle For other castor designs, see Page 15	Fold-out panel on the short sides and/or long sides All-round bumper rail made of plastic GN lid receptacle for accepting GN 1/1 lids and their subdivision For other castor designs, see Page 15	Fold-out panel on the short sides and/or long sides All-round bumper rail made of plastic GN lid receptacle for accepting GN 1/1 lids and their subdivision For other castor designs, see Page 15
Order No.	572 156	572 157	572 551	572 429	572 430

BLANCO INMOTION

Food serving cart, closed

- **Material CNS 18/10** with micro-polished surface,
- **Welded-in, deep-drawn wells** for GN 1/1-200 and its subdivisions for which the wells can be heated wet or dry and can **be heated and regulated individually**,
- **Continuous well temperature** control from +30 °C to +95 °C (except for **SAG 2-THK**: up to +90 °C),
- **Heatable cabinet compartments** for each of 6 x GN 1/1 with 6 pair of support ledges (spacing: 57.5 mm), hygienic design H1, temperature adjustable from +30 °C to +85 °C
- **CNS safety push handle** with side corner guard elements also serves to protect the switch elements,
- **Stamped fill-level marking** in the wells,
- **Drain valve secured** against inadvertent opening,
- **Top surface with profile edge**,
- **Protected against splashed and sprayed water** (IP X5),
- **Suitable for optimization systems**,
- Pursuant to **DIN 18867, Part 7**,
- **Synthetic castors**, 2 fixed and 2 steering castors with brakes, dia. 125 mm, corrosion-resistant pursuant to DIN 18867, Part 8,
- **Solid corner guards** made of plastic (polyamide) protect against damage,
- **VDE and GS certified, CE compliant**,
- **Operating panel** with on/off switch, pilot lamp, helix cord connection with dummy plug socket, temperature control on the short side below the push handle,
- **SAG 2-THK mains voltage**: 220–240 V, 50 Hz, **SAG 2 and SAG 3**: 220–240 V, 50–60 Hz.



Model	SAG 2	SAG 3	SAG 2-THK
Dim. L x W x H (in mm)	936 x 714 x 933 mm Operating height: 900 mm	1276 x 714 x 933 Operating height: 900 mm	1493 x 714 x 933 mm Operating height: 900 mm
Weight (in kg)	62 kg	85,5 kg	140,5 kg
Wattage	1,9 kW	2,85 kW	2,3 kW
Capacity	2 heat retaining wells 2 heatable cabinet compartments	3 heat retaining wells 3 heatable cabinet compartments	2 Heat retaining wells 1 Heatable cabinet compartment 1 Convection-cooled cabinet compartment for 4 x GN 1/1, 4 pair of support brackets, temperature digitally adjustable from +2 °C to +15 °C 1 Heatable plate dispenser for approx. 35 plates (dia. 21-26 cm), plate temperature +60 °C
Special features	—	—	Integrated ladle support, hooded cover bracket and GN lid receptacle for accepting GN 1/1 lids and their subdivisions (attached at short side)
Accessories/Options	Sneeze guard or sneeze guard with heating shelf Fold-out shelf on the short side and/or the long sides Hinged lid 1/3 : 2/3, (1/3 usable as shelf, 2/3 with integrated lid holder) All-round bumper rail made of plastic (polyamide) Sliding cover with synthetic or ball-bearing guide GN lid receptacle for accepting 1/1 GN lids and their subdivision; attached on short side Draw bar left or right Cooling element (eutectic plate) For other castor designs, see Page 15	Sneeze guard or sneeze guard with heating shelf Fold-out shelf on the short sides and/or the long sides Hinged lid 1/3 : 2/3, (1/3 usable as shelf, 2/3 with integrated lid holder) All-round bumper rail made of plastic (polyamide) Sliding cover with synthetic or ball-bearing guide GN lid receptacle for accepting 1/1 GN lids and their subdivision; attached on short side Draw bar left or right Cooling element (eutectic plate) For other castor designs, see Page 15	Sneeze guard or sneeze guard with heating shelf Fold-out shelf attached to long sides Hinged lid 1/3 : 2/3, both can be used as shelf All-round bumper rail made of plastic (polyamide) Lid retention for domed lid of the plate dispenser Model variant: Underframe with 1 heatable cabinet compartment and 1 active cooled compartment, without plate dispenser Model variant: Underframe with 1 heatable cabinet compartment and 1 neutral cabinet compartment with plate dispenser (Order No. 572 222) Model variant: Underframe with 1 heatable cabinet compartment and 1 neutral cabinet compartment without plate dispenser Cooling element (eutectic plate) For other castor designs, see Page 15
Order No.	572 150	572 151	572 161

BLANCO INMOTION

Food transportation carts

- **Material CNS 18/10** with micro-polished surface,
- **Heatable cabinet compartments** for each of 9 x GN 1/1 with 9 pair of support ledges (spacing: 57.5 mm), hygienic design H1, temperature adjustable from +30 °C to +85 °C
- **CNS safety push handle** with side corner guard elements also serves to protect the switch elements,
- **Protected against splashed and sprayed water** (IP X5),
- **Suitable for optimization systems,**
- Pursuant to **DIN 18867, Part 7,**
- **Synthetic castors:** 2 fixed and 2 steering castors with brakes, dia. 125 mm, corrosion-resistant pursuant to DIN 18867, Part 8,
- **Solid corner guards** made of plastic (polyamide) protect against damage,
- **VDE and GS certified, CE compliant,**
- **Operating panel** with on/off switch, pilot lamp, helix cord connection with dummy plug socket, temperature control on the short side below the push handle,
- **Mains voltage** 220–240 V, 50–60 Hz.









Model	STW 2 (shown with GN container accessory)
Dim. L x W x H (in mm)	1009 x 714 x 915 mm Operating height: 885 mm
Weight (in kg)	68,5 kg
Wattage	1,0 kW
Capacity	2 heat retaining wells
Accessories/Options	All-round bumper rail made of plastic (polyamide) Attachment of railing, 3-sided or all-round Electronic temperature control with digital display Draw bar left or right Cooling element (eutectic plate) For other castor designs, see Page 15
Order No.	572 159

We will be happy to provide you with additional information on the BLANCO INMOTION and on the entire BLANCO product line on request (see back for address).

accessories SAW/SAG/STW

The following options/accessories are available for the BLANCO INMOTION food serving and transport carts shown on Pages 10 to 13, depending on the model.

Illustration	Designation	for	Order No.
	Sneeze guard, curved, extends down to top surface on customer side or with a pass-through height of 275 mm on customer side	SAW 2 / SAW L-2 SAG 2 / SAG 2-THK SAW 3 / SAW L-3 / SAG 3 SAW 4 / SAW L-4	optional (for additional fee)
	Sneeze guard, curved, extends down to top surface on customer side or with a pass-through height of 275 mm on customer side, Heating shelf made of stainless steel with 1 ceramic radiator, 250 W per bain-marie, 230 V	SAW 2 / SAW L-2 SAG 2 / SAG 2-THK SAW 3 / SAW L-3 / SAG 3 SAW 4 / SAW L-4 (with 400 V CEE plug)	optional (for additional fee)
	Sliding cover made of CNS 18/10 with water condensation stripper, synthetic guide and all-round railing, height: 50 mm	SAW 2 / SAW 3 SAG 2 / SAG 3	optional (for additional fee)
	Sliding cover made of CNS 18/10 with water condensation stripper, ball-bearing guide and all-round railing, height: 50 mm	SAW 2 / SAW 3 SAG 2 / SAG 3	optional (for additional fee)
Not shown	Railing, 3-sided made of CNS 18/10, height: 50 mm	STW 2 / STW 3	optional (for additional fee)
Not shown	Railing, 4-sided made of CNS 18/10, height: 50 mm	STW 1 / STW 2 / STW 3	optional (for additional fee)
	Fold-down shelf, long side 245 mm wide	SAW 1 / SAW 2 / SAW 3 / SAW 4 SAW 2-UK / SAW 3-UK SAG 2 / SAG 3 / SAG 2-THK	optional (for additional fee)
	Fold-down shelf, short side 245 mm wide	SAW 2 / SAW 3 / SAW 4 SAW 2-UK / SAW 3-UK SAG 2 / SAG 3	optional (for additional fee)
Not shown	Hinged lid 2/3 : 1/3 made of CNS 18/10, 1/3 lid can be used as support surface, 2/3 lid with integrated lid holder	SAW 2 / SAW 3 / SAW 4 SAG 2 / SAG 3 SAG 2-THK (without integrated lid holder, both lids can be used as support surface)	optional (for additional fee)
Not shown	GN lid holder made of CNS 18/10, for GN 1/1 or its subdivision Note: 1) attached at short side opposite push handle 2) attached on long side below push handle	SAW 2 ¹⁾ / SAW 3 ¹⁾ / SAW 4 ¹⁾ SAW L-2 ²⁾ / SAW L-3 ²⁾ / SAW L-4 ²⁾ SAW 2-UK / SAW 3-UK SAG 2 ¹⁾ / SAG 3 ¹⁾	optional (for additional fee)
Not shown	All-round bumper rail	SAG 2 / SAG 3 SAG 2-THK STW 1 / STW 2 / STW 3 SAW 2-UK / SAW 3-UK	optional (for additional fee)
Not shown	Draw bar and coupling made of CNS 18/10	SAG 2 / SAG 3 STW 1 / STW 2 / STW 3	optional (for additional fee)
	Electronic temperature control	STW 2 / STW 3	optional (for additional fee)
	Eutectic plate (-12 °C) made of synthetic, Gastronorm compatible	All SAG, STW 2	573 332
	Eutectic plate (-3 °C) made of synthetic, Gastronorm compatible	All SAG, STW 2	568 136
Not shown	Lid lock for the hooded cover of the plate dispenser	SAG 2-THK	optional (for additional fee)

SAW/SAG/STW castors

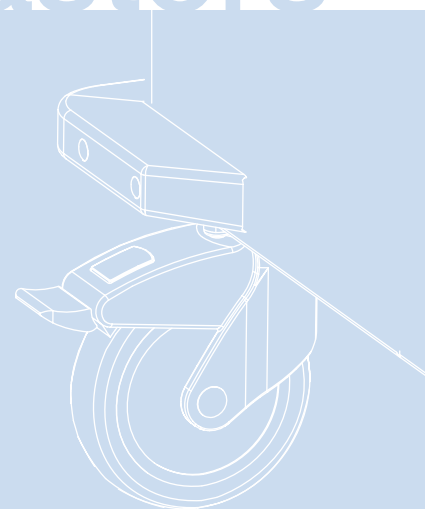

Designation	for models	Order No.
Anti-static castors 4 steering castors, 2 of which have brakes, made of plastic, dia. 125 mm	All SAW	optional (for additional fee)
Anti-static castors 2 fixed, 2 steering castors with brakes, made of plastic, dia. 125 mm	All SAW-UK All SAG All STW	optional (for additional fee)
Stainless-steel castors 4 steering castors, 2 of which have brakes, dia. 125 mm	All SAW All SAW-UK SAG 2 / SAG 3 All STW	optional (for additional fee)
Stainless-steel castors 2 fixed, 2 steering castors with brakes, dia. 160 mm	All SAW-UK All SAG All STW	optional (for additional fee)
Stainless-steel castors 2 fixed, 2 steering castors with brakes, dia. 160 mm	All SAG SAG 2-THK STW 2 / STW 3	optional (for additional fee)
Stainless-steel castors 2 fixed and 4 steering castors, 2 of which have brakes, dia. 160 mm	SAG 2-THK	optional (for additional fee)
Galvanized-steel castors 4 steering castors, 2 of which have brakes, dia. 125 mm	All SAW All SAG STW 1	optional (price reduction)
Galvanized-steel castors 2 fixed, 2 steering castors with brakes, dia. 125 mm	All SAW-UK All SAG STW 2 / STW 3	optional (price reduction)
Galvanized-steel castors 2 fixed, 2 steering castors with brakes, dia. 160 mm	All SAG STW 2 / STW 3 All SAW-UK	optional (for additional fee)
Galvanized-steel castors 2 fixed, 2 steering castors with brakes, dia. 200 mm	All SAG STW 2 / STW 3	optional (for additional fee)
Galvanized-steel castors, 2 fixed, 4 steering castors, 2 of which have brakes, dia. 160 mm	SAG 2-THK	optional (for additional fee)
Pneumatic-tired castors, 2 fixed, 2 steering castors with brakes, dia. 200 mm	All SAG All SAW-UK STW 2 / STW 3	optional (for additional fee)

BLANCO INMOTION

Platform dispenser, heatable

Platform dispenser, unheated / with cooling slits

- **Material CNS 18/10** with micro-polished surface,
- **Spring tension** can be adapted to the weight of the respective porcelain and/or system parts,
- **CNS safety push handle** with side corner guard elements also serves to protect the switch elements,
- **Synthetic castors**, 4 steering castors, 2 of which have brakes, dia. 125 mm, corrosion-resistant pursuant to DIN 18867, Part 8,
- **Solid corner guards** made of plastic (polyamide) protect against damage.

Also with CHV 58/58:

- **Interior unit temperature** adjustable from +30 °C to +110 °C,
- **With polycarbonate hooded cover** (with heated use of the units, operation should usually occur with the hooded cover to prevent unnecessary heat loss),
- **Protected against splashed and sprayed water** (IP X5),

- **Suitable for optimization systems**,
- Pursuant to **DIN 18665, Part 6**
- **VDE and GS certified, CE compliant**,
- **Operating panel** with on/off switch, pilot lamp, helix cord connection with dummy plug socket, temperature control on the short side below the push handle,
- **Mains voltage** 220–240 V, 50 Hz.



Model	CHV 58/58	CE 58/58	CE 88/61	CEK 58/58
		heatable (convection)	unheated	unheated
Dim. L x W x H (in mm)	958 x 714 x 931 mm Operating height: 900 mm	818 x 714 x 931 mm Operating height: 900 mm	1128 x 740 x 931 mm Operating height: 900 mm	818 x 714 x 931 mm Operating height: 900 mm
Interior dims (in mm)	581 x 581 mm	581 x 581 mm	881 x 611 mm	581 x 581 mm
Weight (in kg)	85,0 kg	58,0 kg	74,0 kg	58,0 kg
Voltage/wattage	230 V / 1,8 kW	—	—	—
Capacity	Depending on porcelain/ system parts used	Depending on porcelain/ system parts used	Depending on porcelain/ system parts used	Depending on porcelain/ system parts used
Stack height	w/o hooded cover: 540 mm w/ hooded cover: 680 mm (including hooded cover)	w/o hooded cover: 540 mm w/ hooded cover: 680 mm (hooded cover as accessory)	—	w/o hooded cover: 540 mm w/ hooded cover: 680 mm (hooded cover as accessory)
Special features	Equipped with convection-blower heating Incl. polycarbonate hooded cover (617 x 617 mm)	—	—	—
Accessories/ Options	Decorative model For other castor designs, see Page 31	Polycarbonate hooded cover (625 x 625 mm) Decorative model For other castor designs, see Page 31	Decorative model For other castor designs, see Page 31	Polycarbonate hooded cover (625 x 625 mm) Decorative model For other castor designs, see Page 31
Order No.	572 192	572 193	572 194	572 854

BLANCO INMOTION

Basket dispenser, heatable

Basket dispenser, cooled (convection)

- **Material CNS 18/10** with micro-polished surface,
- **Interior unit temperature can be regulated** from +30 °C to +110 °C (CE-UK 53/53: +2 °C to +15 °C, with ambient temperature of +32 °C),
- **With polycarbonate hooded cover** (with heated or cooled use of the units, operation should usually occur with the hooded cover to prevent unnecessary heat/cool air loss),
- **Spring tension** can be adapted to the weight of the respective porcelain and/or system parts,
- **CNS safety push handle** with side corner guard elements also serves to protect the switch elements,
- **CHV 53/53 and CHV 66/54: Protected against splashed and sprayed water** (IP X5), **CE-UK 53/53: Protected against splashed water** (IP X4),
- Suitable for optimization systems,
- Pursuant to **DIN 18665, Part 6**
- **Synthetic castors**, 4 steering castors, 2 of which have brakes (CE-UK 53/53: 2 fixed and 2 steering castors with brakes), dia. 125 mm, corrosion-resistant pursuant to DIN 18867, Part 8,
- **Solid corner guards** made of plastic (polyamide) protect against damage,
- **VDE certified and GS mark** (not CE-UK 53/53), **CE conformity**,
- **Operating panel** with on/off switch, pilot lamp, **CHV 53/53 and CHV 66/54:** Helix cord connection with dummy plug socket, temperature control below the push handle, **CE-UK 53/53:** digital temperature control below the push handle, helix cord connection and dummy plug socket on long side of unit,
- **Mains voltage** 220–240 V, 50 Hz.



Model	CHV 53/53	CHV 66/54	CE-UK 53/53
	heatable (convection)	heatable (convection)	cooled (convection)
Dim. L x W x H (in mm)	898 x 714 x 931 mm Operating height: 900 mm	1038 x 714 x 931 mm Operating height: 900 mm	1313 x 790 x 1065 mm Operating height: 900 mm
Interior dims (in mm)	535 x 535 mm	660 x 540 mm	535 x 535 mm
Weight (in kg)	70,0 kg	72,0 kg	117,0 kg
Wattage	1,8 kW	1,8 kW	0,4 kW
Capacity	6 baskets of height 115 mm or 9 baskets of height 75 mm	6 baskets of height 115 mm or 9 baskets of height 75 mm	5 baskets of height 115 mm or 8 baskets of height 75 mm
Stack height	w/o hooded cover: 540 mm w/ hooded cover: 680 mm (including hooded cover)	w/o hooded cover: 540 mm w/ hooded cover: 680 mm (including hooded cover)	w/o hooded cover: 540 mm w/ hooded cover: 680 mm (including hooded cover)
Special features	Equipped with convection-blower heating Incl. polycarbonate hooded cover (557 x 557 mm)	Equipped with convection-blower heating Incl. polycarbonate hooded cover (697 x 697 mm)	Convection cooling, cooling capacity: 0.37 kW at $t_0 = -10$ °C (evaporation temp.) and $t_a = +32$ °C (ambient temp.), coolant CFC-free (R 134a) Incl. polycarbonate hooded cover (557 x 557 mm)
Accessories/Options	Steel wire baskets, plastic-coated, 500 x 500 x 75 mm or 500 x 500 x 115 mm, 525 x 525 x 75 mm or 525 x 525 x 115 mm Stainless steel baskets, CNS 18/10, 500 x 500 x 75 mm or 500 x 500 x 115 mm, 525 x 525 x 75 mm or 525 x 525 x 115 mm Decorative model For other castor designs, see Page 31	Steel wire baskets, plastic-coated, 650 x 530 x 75 mm or 650 x 530 x 115 mm Stainless steel baskets, CNS 18/10, 650 x 530 x 75 mm or 650 x 530 x 115 mm Decorative model For other castor designs, see Page 31	Steel wire baskets, plastic-coated, 500 x 500 x 75 mm, 500 x 500 x 115 mm, 525 x 525 x 75 mm, 525 x 525 x 115 mm Stainless steel baskets, CNS 18/10, 500 x 500 x 75 mm, 500 x 500 x 115 mm, 525 x 525 x 75 mm, 525 x 525 x 115 mm 12 guide rods for use of the unit as a universal dispenser (Order No. 572 454) All-round bumper rail made of plastic (polyamide) For other castor designs, see Page 31
Order No.	572 185	572 186	572 431

We will be happy to provide you with additional information on the BLANCO INMOTION and on the entire BLANCO product line on request (see back for address).

BLANCO INMOTION

Basket dispenser, unheated

Basket dispenser with cooling slits

- **Material CNS 18/10** with micro-polished surface,
- **Spring tension** can be adapted to the weight of the respective porcelain and/or system parts,
- **CNS safety push handle** with side corner guard elements,
- **Synthetic castors**, 4 steering castors, 2 of which have brakes, dia. 125 mm, corrosion-resistant pursuant to DIN 18867, Part 8,
- **Solid corner guards** made of plastic (polyamide) protect against damage.

With CEK 53/53 only:

- **Unit body with cooling slits** to cool dishes in refrigerated rooms.

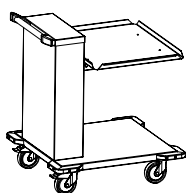

Model	CCE 53/53 (shown with basket)	CCE 66/54	CE 53/53	CE 66/54	CEK 53/53
	unheated	unheated	unheated	unheated	with cooling slits
Dim. L x W x H (in mm)	816 x 543 x 931 mm Op. height: 900 mm	816 x 700 x 931 mm Op. height: 900 mm	758 x 714 x 931 mm Op. height: 900 mm	898 x 714 x 931 mm Op. height: 900 mm	758 x 714 x 931 mm Op. height: 900 mm
Interior dims (in mm)	536 x 536 mm	656 x 536 mm	535 x 535 mm	660 x 540 mm	535 x 535 mm
Weight (in kg)	33,0 kg	37,0 kg	43,0 kg	48,0 kg	42,0 kg
Capacity	6 baskets of height 115 mm or 10 baskets of height 75 mm	6 baskets of height 115 mm or 10 baskets of height 75 mm	6 baskets of height 115 mm or 10 baskets of height 75 mm	6 baskets of height 115 mm or 9 baskets of height 75 mm	6 baskets of height 115 mm or 9 baskets of height 75 mm
Stack height	700 mm	700 mm	without hooded cover: 540 mm with hooded cover: 680 mm (accessory)	without hooded cover: 540 mm with hooded cover: 680 mm (accessory)	without hooded cover: 540 mm with hooded cover: 680 mm (accessory)
Accessories/Options	Steel wire baskets, plastic-coated, 500 x 500 x 75 mm, 500 x 500 x 115 mm, 525 x 525 x 75 mm, 525 x 525 x 115 mm Stainless steel baskets, CNS 18/10, 500 x 500 x 75 mm, 500 x 500 x 115 mm, 525 x 525 x 75 mm, 525 x 525 x 115 mm Decorative model For other castor designs, see Page 31	Steel wire baskets, plastic-coated, 650 x 530 x 75 mm, 650 x 530 x 115 mm Stainless steel baskets, CNS 18/10, 650 x 530 x 75 mm, 650 x 530 x 115 mm Decorative model For other castor designs, see Page 31	Steel wire baskets, plastic-coated, 500 x 500 x 75 mm, 500 x 500 x 115 mm, 525 x 525 x 75 mm, 525 x 525 x 115 mm Stainless steel baskets, CNS 18/10, 500 x 500 x 75 mm, 500 x 500 x 115 mm, 525 x 525 x 75 mm, 525 x 525 x 115 mm Polycarbonate hooded cover (557 x 557 mm) Decorative model For other castor designs, see Page 31	Steel wire baskets, plastic-coated, 650 x 530 x 75 mm, 650 x 530 x 115 mm Stainless steel baskets, CNS 18/10, 650 x 530 x 75 mm, 650 x 530 x 115 mm Polycarbonate hooded cover (697 x 557 mm) Decorative model For other castor designs, see Page 31	Steel wire baskets, plastic-coated, 500 x 500 x 75 mm, 500 x 500 x 115 mm, 525 x 525 x 75 mm, 525 x 525 x 115 mm Stainless steel baskets, CNS 18/10, 500 x 500 x 75 mm, 500 x 500 x 115 mm, 525 x 525 x 75 mm, 525 x 525 x 115 mm Polycarbonate hooded cover (557 x 557 mm) For other castor designs, see Page 31
Order No.	572 187	572 188	572 189	572 190	572 191

BLANCO INMOTION

Tray dispenser, open

Tray dispenser, closed

- **Material CNS 18/10** with micro-polished surface,
- **Spring tension** can be adjusted to the weight of the respective trays,
- **CNS safety push handle** with side corner guard elements,
- **Synthetic castors**, 4 steering castors, 2 of which have brakes, dia. 125 mm, corrosion-resistant pursuant to DIN 18867, Part 8,
- **Solid corner guards** made of plastic (polyamide) protect against damage.

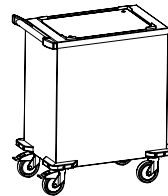

Model	CCE 54/38 (without trays)	CCE-A	CE 54/38
	open	open	closed
Dim. L x W x H (in mm)	816 x 543 x 931 mm Operating height: 900 mm	906 x 514 x 931 mm Operating height: 900 mm	785 x 514 x 931 mm Operating height: 900 mm
Weight (in kg)	31,5 kg	35 kg	48,5 kg
Capacity	approx. 100 trays, 530 x 370 mm	approx. 100 trays, 530 x 370 mm	approx. 100 trays, 530 x 370 mm
Stack height	700 mm	700 mm	540 mm
Special features	—	Model for use on conveyor, with two side tray guides	Unit body closed
Accessories/ Options	Decorative model Silverware attachment with or without napkin dispenser For other castor designs, see Page 31	Decorative model For other castor designs, see Page 31	Decorative model Silverware attachment with or without napkin dispenser For other castor designs, see Page 31
Order No.	572 183	572 184	572 469

We will be happy to provide you with additional information on the BLANCO INMOTION and on the entire BLANCO product line on request (see back for address).

BLANCO INMOTION

Universal dispenser, heatable

- **Material CNS 18/10** with micro-polished surface,
- **Interior unit temperature** adjustable from +30 °C to +110 °C,
- **With polycarbonate hooded cover** (with heated use of the units, operation should usually occur with the hooded cover to prevent unnecessary heat loss),
- Using the **variably groupable synthetic guide rods**, a wide variety of dish types can be stacked,
- Synthetic guide rods prevent porcelain from being worn,
- **Spring tension** can be adapted to the weight of the respective porcelain and/or system parts,
- **CNS safety push handle** with side corner guard elements also serves to protect the switch elements,
- **Protected against splashed and sprayed water** (IPX 5),
- **Suitable for optimization systems**,
- Pursuant to **DIN 18665, Part 6**
- **Synthetic castors**, 4 steering castors, 2 of which have brakes, dia. 125 mm, corrosion-resistant pursuant to DIN 18867, Part 8,
- **Solid corner guards** made of plastic (polyamide) protect against damage,
- **VDE and GS certified, CE compliant**,
- **Operating panel** with on/off switch, pilot lamp, helix cord connection with dummy plug socket, temperature control on the short side below the push handle,
- **Mains voltage** 220–240 V, 50 Hz.



Model	UNI-H 59/29 (without plates)	UNI-H 58/58
	heatable (convection)	heatable (convection)
Dim. L x W x H (in mm)	898 x 514 x 931 mm Operating height: 900 mm	958 x 714 x 931 mm Operating height: 900 mm
Interior dims (in mm)	590 x 290 mm	580 x 580 mm
Weight (in kg)	68,5 kg	92,5 kg
Wattage	1,8 kW	1,8 kW
Capacity	Depending on porcelain/ system parts used	Depending on porcelain/ system parts used
Stack height	w/o hooded cover: 540 mm w/ hooded cover: 680 mm (including hooded cover)	w/o hooded cover: 540 mm w/ hooded cover: 680 mm (including hooded cover)
Special features	6 variably groupable synthetic guide rods allow stacking of a variety of porcelain/system parts Incl. polycarbonate hooded cover (640 x 340 mm)	8 variably groupable synthetic guide rods allow stacking of a variety of porcelain/system parts Incl. polycarbonate hooded cover (617 x 617 mm)
Accessories/ Options	Decorative model For other castor designs, see Page 31	Decorative model For other castor designs, see Page 31
Order No.	572 195	572 196

BLANCO INMOTION

Universal dispenser, unheated

Universal dispenser with cooling slits

- **Material CNS 18/10** with micro-polished surface,
- Using the **variably groupable synthetic guide rods**, a wide variety of dish types can be stacked,
- **Synthetic guide rods** prevent porcelain from being worn,
- **Spring tension** can be adapted to the weight of the respective porcelain and/or system parts,

- **CNS safety push handle** with side corner guard elements,
- **Synthetic castors**, 4 steering castors, 2 of which have brakes, dia. 125 mm, corrosion-resistant pursuant to DIN 18867, Part 8,
- **Solid corner guards** made of plastic (polyamide) protect against damage.

Also for UNI-K 59/29 and UNI-K 58/58:

- **Unit body with cooling slits** to cool dishes in refrigerated rooms.

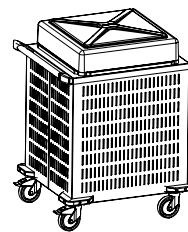
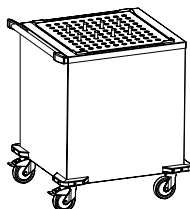

Model	UNI 59/29 (without plates)	UNI 58/58	UNI-K 59/29 (without plates)	UNI-K 58/58 shown with hooded cover accessory
	unheated	unheated	with cooling slits	with cooling slits
Dim. L x W x H (in mm)	788 x 514 x 931 mm Operating height: 900 mm			818 x 714 x 931 mm Operating height: 900 mm
Interior dims (in mm)	590 x 290 mm			580 x 580 mm
Weight (in kg)	48,5 kg	66,0 kg	48,0 kg	65,5 kg
Wattage	—	—	—	—
Capacity	Depending on porcelain/ system parts used	Depending on porcelain/ system parts used	Depending on porcelain/ system parts used	Depending on porcelain/ system parts used
Stack height	w/o hooded cover: 540 mm w/ hooded cover: 680 mm (hooded cover as accessory)	w/o hooded cover: 540 mm w/ hooded cover: 680 mm (hooded cover as accessory)	w/o hooded cover: 540 mm w/ hooded cover: 680 mm (hooded cover as accessory)	w/o hooded cover: 540 mm w/ hooded cover: 680 mm (hooded cover as accessory)
Special features	6 variably groupable synthetic guide rods allow stacking of a variety of porcelain/system parts	8 variably groupable synthetic guide rods allow stacking of a variety of porcelain/system parts	Unit body with cooling slits 6 variably groupable synthetic guide rods allow stacking of a variety of porcelain/system parts	Unit body with cooling slits 8 variably groupable synthetic guide rods allow stacking of a variety of porcelain/system parts
Accessories/ Options	Polycarbonate hooded cover (640 x 340 mm) Decorative model For other castor designs, see Page 31	Polycarbonate hooded cover (617 x 617 mm) Decorative model For other castor designs, see Page 31	Polycarbonate hooded cover (640 x 340 mm) For other castor designs, see Page 31	Polycarbonate hooded cover (617 x 617 mm) For other castor designs, see Page 31
Order No.	572 197	572 198	572 199	572 468

We will be happy to provide you with additional information on the BLANCO INMOTION and on the entire BLANCO product line on request (see back for address).

BLANCO INMOTION

Plate dispenser, heatable

- **Material CNS 18/10** with micro-polished surface,
- **Interior unit temperature** adjustable from +30 °C to +110 °C (2 SHVS 21-26: up to +130 °C),
- **Powerful heating element** made of CNS 18/10,
- **With polycarbonate hooded cover** (with heated use of the units, operation should usually occur with the hooded cover to prevent unnecessary heat loss),
- **Synthetic guide rods** prevent porcelain from being worn,
- **Spring tension** can be adjusted to the weight of the respective plates,
- **CNS safety push handle** with side corner guard elements also serves to protect the switch elements,
- **Protected against splashed and sprayed water** (IP X5),
- **Suitable for optimization systems**, Pursuant to **DIN 18665, Part 6**
- **Synthetic castors**, 4 steering castors, 2 of which have brakes, dia. 125 mm, corrosion-resistant pursuant to DIN 18867, Part 8,
- **Solid corner guards** made of plastic (polyamide) protect against damage,
- **VDE and GS certified, CE compliant**,
- **Operating panel** with on/off switch, pilot lamp, helix cord connection with dummy plug socket, temperature control on the short side below the push handle,
- **Mains voltage** 220–240 V, 50–60 Hz.



Model	1 SHE 21-26	1 SHE 26-31	2 SHE 21-26	2 SHE 26-31
		heatable	heatable	heatable
Dim. L x W x H (in mm)	653 x 513 x 931 mm Operating height: 900 mm	653 x 513 x 931 mm Operating height: 900 mm	898 x 513 x 931 mm Operating height: 900 mm	1018 x 513 x 931 mm Operating height: 900 mm
Interior dims (in mm)	dia. 210–260 mm	dia. 260–310 mm	dia. 210–260 mm	dia. 260–310 mm
Weight (in kg)	34,5 kg	35,0 kg	45,0 kg	49,5 kg
Wattage	0,9 kW	0,9 kW	1,8 kW	1,8 kW
Capacity	1 tube, approx. 60 plates total capacity	1 tube, approx. 60 plates total capacity	2 tubes, approx. 120 plates total capacity	2 tubes, approx. 120 plates total capacity
Stack height	w/o hooded cover: 620 mm w/ hooded cover: 670 mm (including hooded cover)	w/o hooded cover: 620 mm w/ hooded cover: 670 mm (including hooded cover)	w/o hooded cover: 620 mm w/ hooded cover: 670 mm (including hooded cover)	w/o hooded cover: 620 mm w/ hooded cover: 670 mm (including hooded cover)
Special features	Incl. polycarbonate hooded cover	Incl. polycarbonate hooded cover	Incl. polycarbonate hooded cover	Incl. polycarbonate hooded cover
Accessories/Options	Lid lock on the cover Decorative model For other castor designs, see Page 31	Lid lock on the cover Decorative model For other castor designs, see Page 31	Lid lock on the cover Decorative model For other castor designs, see Page 31	Lid lock on the cover Decorative model For other castor designs, see Page 31
Order No.	572 162	572 163	572 164	572 165



Model	2 SHV 21-26	2 SHV 26-31	2 SHVS 26
	heatable (convection)	heatable (convection)	heatable (convection)
Dim. L x W x H (in mm)	958 x 513 x 931 mm Operating height: 900 mm	1018 x 513 x 931 mm Operating height: 900 mm	1144 x 548 x 1062 mm Operating height: 970 mm
Interior dims (in mm)	dia. 210–260 mm	dia. 260–310 mm	dia. 260 mm
Weight (in kg)	48,0 kg	51,0 kg	82,0 kg
Wattage	1,8 kW	1,8 kW	3,0 kW
Capacity	2 tubes, approx. 120 plates total capacity	2 tubes, approx. 120 plates total capacity	2 tubes, approx. total capacity: 76 heat-retaining plates
Stack height	w/o hooded cover: 620 mm w/ hooded cover: 670 mm (including hooded cover)	w/o hooded cover: 620 mm w/ hooded cover: 670 mm (including hooded cover)	Stack height: 620 mm CNS hinged lids permanently mounted to unit
Special features	Incl. polycarbonate hooded cover Equipped with convection-blower heating	Incl. polycarbonate hooded cover Equipped with convection-blower heating	Especially for wax-filled heat-retaining plates made of CNS Equipped with convection-blower heating
Accessories/ Options	Lid lock on the cover Decorative model For other castor designs, see Page 31	Lid lock on the cover Decorative model For other castor designs, see Page 31	Decorative model For other castor designs, see Page 31
Order No.	572 166	572 167	572 908

We will be happy to provide you with additional information on the BLANCO INMOTION and on the entire BLANCO product line on request (see back for address).

BLANCO INMOTION

Plate dispenser, unheated

Plate dispenser with cooling slits

- **Material CNS 18/10** with micro-polished surface,
- **Spring tension** can be adjusted to the weight of the respective plates,
- **Synthetic guide rods** prevent porcelain from being worn,
- **CNS safety push handle** with side corner guard elements,

- **Synthetic castors**, 4 steering castors, 2 of which have brakes, dia. 125 mm, corrosion-resistant pursuant to DIN 18867, Part 8,
- **Solid corner guards** made of plastic (polyamide) protect against damage.

Also for 2 SEK 21-26 and 2 SEK 26-31:

- **Unit body with cooling slits** to cool dishes in refrigerated rooms.



Model	2 SE 21-26	2 SE 26-31	3 SE 18-21 (not shown)	2 SEK 21-26 (without plates)	2 SEK 26-31	
	unheated	unheated	unheated	with cooling slits	with cooling slits	
Dim. L x W x H (in mm)	788 x 513 x 931 mm Op.height: 900 mm	818 x 513 x 931 mm Op.height: 900 mm	948 x 513 x 931 mm Op.height: 900 mm	788 x 513 x 931 mm Op.height: 900 mm	869 x 513 x 931 mm Op.height: 900 mm	
Interior dims (in mm)	dia. 210–260 mm	dia. 260–310 mm	dia. 180–210 mm	dia. 210–260 mm	dia. 260–310 mm	
Weight (in kg)	26,5 kg	28,0 kg	31,0 kg	26,0 kg	27,0 kg	
Capacity	2 tubes, approx. 120 plates total capacity	2 tubes, approx. 120 plates total capacity	3 tubes, approx. 180 plates total capacity	2 tubes, approx. 120 plates total capacity	2 tubes, approx. 120 plates total capacity	
Stack height	w/o hooded cover: 620 mm w/ hooded cover: 670 mm (hooded cover as accessory)	w/o hooded cover: 620 mm w/ hooded cover: 670 mm (hooded cover as accessory)	w/o hooded cover: 620 mm	w/o hooded cover: 620 mm w/ hooded cover: 670 mm (hooded cover as accessory)	w/o hooded cover: 620 mm w/ hooded cover: 670 mm (hooded cover as accessory)	
Special features	—	—	—	Unit body with cooling slits	Unit body with cooling slits	
Accessories/Options	Polycarbonate hooded cover	Polycarbonate hooded cover	Decorative model For other castor designs, see Page 31	Polycarbonate hooded cover	Polycarbonate hooded cover	
	Decorative model	Decorative model		Lid lock on the cover	Lid lock on the cover	
	Lid lock on the cover	Lid lock on the cover		For other castor designs, see Page 31	For other castor designs, see Page 31	For other castor designs, see Page 31
	For other castor designs, see Page 31	For other castor designs, see Page 31				
Order No.	572 173	572 174	572 907	572 175	572 176	

BLANCO INMOTION

Basket dispenser for installation

- **Material CNS 18/10**
with micro-polished surface,
- **Spring tension** can be adapted to the weight of the respective porcelain and/or system parts,
- The basket dispenser is open to allow **installation from below**.

Also for CEBH 50/50:

- **Interior unit temperature** adjustable from +30 °C to +110 °C,
- **With polycarbonate hooded cover** (with heated use of the units, operation should usually occur with the hooded cover to prevent unnecessary heat loss),

- **Suitable for optimization systems,**
- Pursuant to **DIN 18665, Part 6**
- **VDE and GS certified, CE compliant,**
- **Mains voltage 220–240 V, 50 Hz.**



Model	CEB 50/50	CEBH 50/50
	unheated	heatable
Dim. L x W x H (in mm)	600 x 545 x 765 to 865 mm	700 x 691 x 785 mm
Interior dims (in mm)	520 x 520 mm	520 x 520 mm
Weight (in kg)	19,0 kg	64,5 kg
Wattage	—	1,8 kW
Capacity	6 baskets (each 115 mm high) or 10 baskets (each 75 mm high)	6 baskets (each 115 mm high) or 10 baskets (each 75 mm high)
Stack height	w/o hooded cover: 540 mm w/ hooded cover: 680 mm (hooded cover as accessory)	w/o hooded cover: 540 mm w/ hooded cover: 680 mm (including hooded cover)
Special features	—	Incl. polycarbonate hooded cover (557 x 557 mm)
Accessories/Options	Hooded cover (polycarbonate) Steel wire baskets, plastic-coated, 500 x 500 x 75 mm or 500 x 500 x 115 mm Stainless steel baskets, CNS 18/10, 500 x 500 x 75 mm or 500 x 500 x 115 mm All-round flange for installation from above (Order No. 590 103)	Steel wire baskets, plastic-coated, 500 x 500 x 75 mm or 500 x 500 x 115 mm Stainless steel baskets, CNS 18/10, 500 x 500 x 75 mm or 500 x 500 x 115 mm
Order No.	590 025	572 206

We will be happy to provide you with additional information on the BLANCO INMOTION and on the entire BLANCO product line on request (see back for address).

BLANCO INMOTION

Plate dispenser for installation,
unheated and heatable

- **Material CNS 18/10**

with micro-polished surface,

- **Spring tension** can be adjusted to the weight of the respective plates,
- **Synthetic guide rods** prevent porcelain from being worn,
- The plate dispenser is **open to allow installation**.

Also for heatable models:

- **Interior unit temperature** adjustable from +30 °C to +110 °C,
- **With polycarbonate hooded cover** (with heated use of the units, operation should usually occur with the hooded cover to prevent unnecessary heat loss),
- **VDE certified,**
- **Mains voltage** 220–240 V, 50 Hz,
- **Connection value** 0.55 kW.



Model	RE 18-21 ET 672	RE 18-21 ET 746	RE 21-26 ET 672	RE 21-26 ET 746	RE 26-31 ET 672
	unheated	unheated	unheated	unheated	unheated
Dim. L x W x H (in mm)	305 x 305 x 680 mm Cut-out dimensions: 292 x 292 mm	305 x 305 x 754 mm Cut-out dimensions: 292 x 292 mm	355 x 355 x 680 mm Cut-out dimensions: 342 x 342 mm	355 x 355 x 754 mm Cut-out dimensions: 342 x 342 mm	405 x 405 x 680 mm Cut-out dimensions: 392 x 392 mm
Interior dims (in mm)	dia. 180–210 mm	dia. 180–210 mm	dia. 210–260 mm	dia. 210–260 mm	dia. 260–310 mm
Weight (in kg)	4,5 kg	4,5 kg	5,0 kg	5,5 kg	6 kg
Wattage	—	—	—	—	—
Capacity	1 tube, approx. 55 plates total capacity	1 tube, approx. 60 plates total capacity	1 tube, approx. 55 plates total capacity	1 tube, approx. 60 plates total capacity	1 tube, approx. 55 plates total capacity
Stack height	540 mm	620 mm	w/o hooded cover: 540 mm, w/ hooded cover: 600 mm (hooded cover accessory)	w/o hooded cover: 620 mm, w/ hooded cover: 670 mm (hooded cover accessory)	w/o hooded cover: 540 mm, w/ hooded cover: 600 mm (hooded cover accessory)
Special features	—	—	—	—	—
Accessories/ Options	Installation from above	Installation from above	Installation from above Polycarbonate hooded tube cover	Installation from above Polycarbonate hooded tube cover	Installation from above Polycarbonate hooded tube cover
Order No.	572 177	572 178	572 179	572 181	572 180



Model	RE 26-31 ET 746	RHE 21-26 ET 668	RHE 21-26 ET 802	RHE 26-31 ET 668	RHE 26-31 ET 802
	unheated	heatable	heatable	heatable	heatable
Dimensions L x W x H (in mm)	405 x 405 x 754 mm Cut-out dimensions: 392 x 392 mm	355 x 355 x 676 mm Cut-out dimensions: 345 x 345 mm	355 x 355 x 810 mm Cut-out dimensions: 345 x 345 mm	405 x 405 x 676 mm Cut-out dimensions: 395 x 395 mm	405 x 405 x 810 mm Cut-out dimensions: 395 x 395 mm
Interior dims (in mm)	dia. 260–310 mm	dia. 210–260 mm	dia. 210–260 mm	dia. 260–310 mm	dia. 260–310 mm
Weight (in kg)	6,0 kg	13,5 kg	14,5 kg	15,5 kg	17,5 kg
Wattage	—	0,55 kW	0,55 kW	0,55 kW	0,55 kW
Capacity	1 tube, approx. 60 plates total capacity	1 tube, approx. 55 plates total capacity	1 tube, approx. 70 plates total capacity	1 tube, approx. 55 plates total capacity	1 tube, approx. 70 plates total capacity
Stack height	w/o hooded cover: 620 mm, w/ hooded cover: 670 mm (hooded cover accessory)	w/o hooded cover: 480 mm, w/ hooded cover: 535 mm (hooded cover included)	w/o hooded cover: 620 mm, w/ hooded cover: 670 mm (hooded cover included)	w/o hooded cover: 480 mm, w/ hooded cover: 535 mm (hooded cover included)	w/o hooded cover: 620 mm, w/ hooded cover: 670 mm (hooded cover included)
Special features	—	Incl. polycarbonate hooded cover	Incl. polycarbonate hooded cover	Incl. polycarbonate hooded cover	Incl. polycarbonate hooded cover
Accessories/ Options	Installation from above Polycarbonate hooded tube cover	Installation from above	Installation from above	Installation from above	Installation from above
Order No.	572 182	572 170	572 169	572 172	572 171

We will be happy to provide you with additional information on the BLANCO INMOTION and on the entire BLANCO product line on request (see back for address).

BLANCO INMOTION

Tray dispenser for installation

- **Material CNS 18/10**
with micro-polished surface,
- **Spring tension** can be adjusted to the weight of the respective trays,
- The tray dispenser is **open to allow installation**.



Model	CEB 47/36	CEB 47/36 (shown without flange)	CEB 53/37	CEB 53/37 (shown without flange)
	Installation from below	Installation from above	Installation from below	Installation from above
Dim. L x W x H (in mm)	585 x 405 x 765 to 865 mm	585 x 405 x 765 to 865 mm	615 x 405 x 765 to 865 mm	615 x 405 x 765 to 865 mm
Interior dims (in mm)	490 x 380 mm	490 x 380 mm	540 x 380 mm	540 x 380 mm
Weight (in kg)	16,5 kg	19 kg	17,0 kg	19,5 kg
Capacity	Approx. 100 trays, 470 x 360 mm	Approx. 100 trays, 470 x 360 mm	Approx. 100 trays, 530 x 370 mm	Approx. 100 trays, 530 x 370 mm
Special features	—	Incl. all-round flange	—	Incl. all-round flange
Accessories/Options	—	—	—	—
Order No.	590 023	564 021	590 024	564 022

We will be happy to provide you with additional information on the BLANCO INMOTION and on the entire BLANCO product line on request (see back for address).

BLANCO INMOTION

Universal dispenser for installation

- **Material CNS 18/10** with micro-polished surface,
- Using the **8 variably groupable synthetic guide rods**, a wide variety of dish types can be stacked,
- **Synthetic guide rods** prevent porcelain from being worn,
- **Spring tension** can be adapted to the weight of the respective porcelain and/or system parts,
- The universal dispenser is closed to allow **installation from below**.

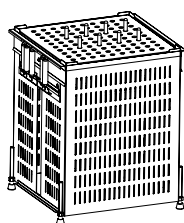
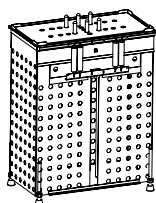

Model	UNI-B 59/29	UNI-B 58/58
	unheated	unheated
Dim. L x W x H (in mm)	613 x 375 x 765 to 865 mm	587 x 663 x 765 to 865 mm
Interior dims (in mm)	590 x 290 mm	581 x 581 mm
Weight (in kg)	32,0 kg	36,0 kg
Capacity	Depending on porcelain/ system parts used	Depending on porcelain/ system parts used
Stack height	w/o hooded cover: 540 mm w/ hooded cover: 680 mm (hooded cover as accessory)	w/o hooded cover: 540 mm w/ hooded cover: 680 mm (including hooded cover)
Special features	8 variably groupable synthetic guide rods allow stacking of a variety of porcelain/system parts	8 variably groupable synthetic guide rods allow stacking of a variety of porcelain/system parts
Accessories/Options	Polycarbonate hooded cover (640 x 340 mm) All-round flange for installation from above (Order No. 572 472)	Polycarbonate hooded cover (617 x 617 mm) All-round flange for installation from above (Order No. 572 473)
Order No.	572 470	572 471

accessories dispenser

The following options/accessories are available for the BLANCO INMOTION platform, basket, tray, universal and plate dispensers shown on Pages 16 to 29, depending on the model.

Illustration	Designation	for models		Order No.
Not shown	Lid lock	all plate dispensers	—	optional (for additional fee)
Not shown	Decorative cladding Stainless-steel backing in red, blue, green or yellow	for all mobile dispensers (except dispensers with cooling slits)	—	on request
Not shown	Decorative cladding Full-surface decoration	for all mobile dispensers (except dispensers with cooling slits)	—	on request
	Steel wire baskets, plastic-coated, mesh width: 35 x 25 mm, mesh wire dia. 2.5 mm, frame wire dia. 6.0 mm	CE 53/53, CHV 53/53, CCE 53/53, CE-UK 53/53, CEBH 50/50, CEB 50/50	500 x 500 x 75 mm 500 x 500 x 115 mm	144 801 144 802
		CE 66/54, CHV 66/54, CCE 66/54	650 x 530 x 75 mm 650 x 530 x 115 mm	952 032 952 033
		CHV 53/53, CE 53/53, CCE 53/53, CE-UK 53/53	525 x 525 x 75 mm 525 x 525 x 115 mm	296 284 296 285
	Stainless steel baskets, CNS 18/10 electropolished, mesh width: 35 x 25 mm, mesh wire dia. 2.5 mm, frame wire dia. 6.0 mm	CE 53/53, CHV 53/53, CCE 53/53, CE-UK 53/53, CEBH 50/50, CEB 50/50	500 x 500 x 75 mm 500 x 500 x 115 mm	144 803 144 804
		CE 66/54, CHV 66/54, CCE 66/54	650 x 530 x 75 mm 650 x 530 x 115 mm	952 030 952 031
		CHV 53/53, CE 53/53, CCE 53/53, CE-UK 53/53	525 x 525 x 75 mm 525 x 525 x 115 mm	296 286 296 287
	Hooded tube cover round, transparent, made of plastic	SE 21-26, SHE 21-26, SHV 21-26, RE 21-26, RHE 21-26, SEK 21-26	dia. 360 mm	146 581
		SE 26-31, SHE 26-31, SHV 26-31, RE 26-31, RHE 26-31, SEK 26-31	dia. 410 mm	146 582
	Hooded tube cover angular, transparent, made of plastic	UNI 59/29, UNI-H 59/29, UNI-K 59/29	640 x 340 mm	146 904
		CHV 66/54, CE 66/54	697 x 577 mm	296 815
		CHV 58/58, UNI 58/58, UNI-H 58/58, UNI-K 58/28, CE 58/58, CEK 58/58	617 x 617 mm	296 814
		CHV 53/53, CEBH 50/50, CEB 50/50, CEK 53/53, CE-UK 53/53, CE 53/53	557 x 557 mm	296 813
	Silverware attachment without napkin dispenser	CCE 53/53	525 x 280 x 210 mm	590 202
		CCE 54/38	710 x 280 x 323 mm	590 206
	Silverware attachment with napkin dispenser	CCE 53/53	525 x 280 x 335 mm	590 203
		CCE 54/38	710 x 343 x 368 mm	590 207

dispenser castors

Designation	for models	Order No.
Anti-static castors 2 fixed, 2 steering castors with brakes, made of plastic, dia. 125 mm	CE-UK 53/53	optional (for additional fee)
Stainless-steel castors 4 steering castors, 2 of which have brakes, dia. 125 mm	all mobile dispensers	optional (for additional fee)
Stainless-steel castors 2 fixed, 2 steering castors with brakes, dia. 125 mm	CE-UK 53/53	optional (for additional fee)
Stainless-steel castors 2 fixed, 2 steering castors with brakes, dia. 160 mm	CE-UK 53/53	optional (for additional fee)
Galvanized-steel castors 4 steering castors, 2 of which have brakes dia. 125 mm	all mobile dispensers	optional (price reduction)
Galvanized-steel castors 2 fixed, 2 steering castors with brakes, dia. 160 mm	CE-UK 53/53	optional (for additional fee)
Galvanized-steel castors 2 fixed, 2 steering castors with brakes, dia. 200 mm	CE-UK 53/53	optional (for additional fee)

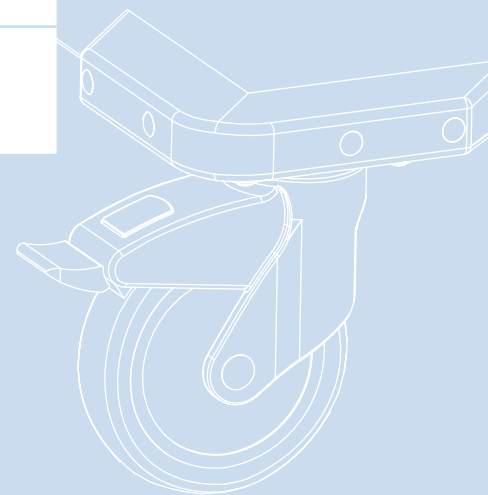



BLANCO
PROFESSIONAL

125424, г. Москва, Волоколамское шоссе, д. 88, стр. 8
Тел./факс: +74955404600

РУССКИЙ ПРОЕКТ[®]
www.rp.ru